



SMAJ350CA SURFACE MOUNT TRANSIENT VOLTAGE SUPPRESSOR



Features

- For surface mounted applications in order to optimize board space
- Low profile package
- Built-in strain relief
- Glass passivated junction
- Low inductance
- Excellent clamping capability
- Repetition rate (duty cycle): 0.01%
- High temperature soldering: 250° C/10 seconds at terminals
- Plastic package has Underwriters Laboratory Flammability Classification 94 V-0

Mechanical Data

- Case: SMA Low Profile Molded Plastic
- Terminals: Solder Plated , Solderable per MIL-STD-750, Method 2026
- Mounting Position: Any
- Polarity: Bipolar
- Weight: 0.064 grams (approx.)

Maximum Ratings and Thermal Characteristics @ T_A=25°C unless otherwise specified

Characteristic	Symbol	Value	Unit
Junction Temperature Range	T _J	-65 to +150	°C
Storage Temperature Range	T _{STG}	-65 to +150	°C
Peak Pulse Power (with 10/1000µs waveform) (Fig.1)(Note 1), (Note 2)	P _{PPM}	400	W
Typical Thermal Resistance Junction to Lead	R _{θJL}	30	°C/W
Typical Thermal Resistance Junction to Ambient	R _{θJA}	120	°C/W

Note: 1. Non-repetitive current pulse, per Fig.3 and derated above T_a=25 °C per Fig.2.
 2. Mounted on Copper Pad area of 5.0x5.0 mm to each terminal.

Ordering Information

Device	Package	Shipping
SMAJ350CA	SMA (Pb-Free)	5000pcs / reel

For information on tape and reel specifications, including part orientation and tape sizes, please refer to our tape and reel packaging specification.

Marking Diagram

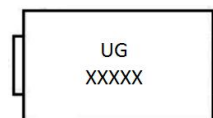

Where XXXXX is YYWWL

UG = Marking code
 YY = Year
 WW = Week
 L = Lot Number

Cautions: Molding resin
 Epoxy resin UL:94V-0

Electrical Characteristics @ $T_A=25^\circ\text{C}$ unless otherwise specified

Part Number	Marking code	Reverse Stand off Voltage V_R	Breakdown Voltage V_{BR} (Volts) @ I_T		Test Current I_T	Maximum Clamping Voltage V_C @ I_{pp}	Maximum Peak Pulse Current I_{pp}	Maximum Reverse Leakage I_R @ V_R
		(Volts)	MIN.	MAX.	(mA)	(Volts)	(A)	(μA)
SMAJ350CA	UG	350	391	432	1	567	0.7	5

Ratings and Characteristics Curves

Fig. 1 - Peak Pulse Power Rating

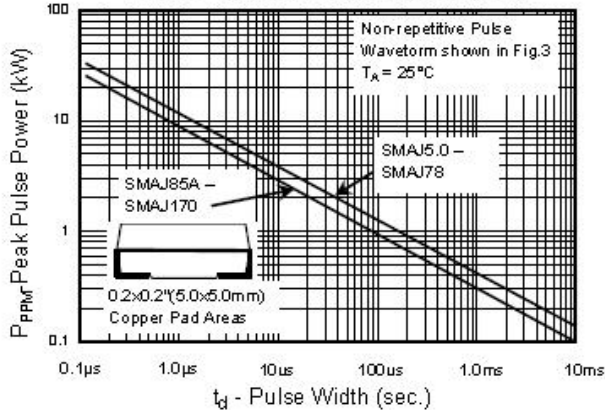

Fig.2 - Pulse Derating Curve

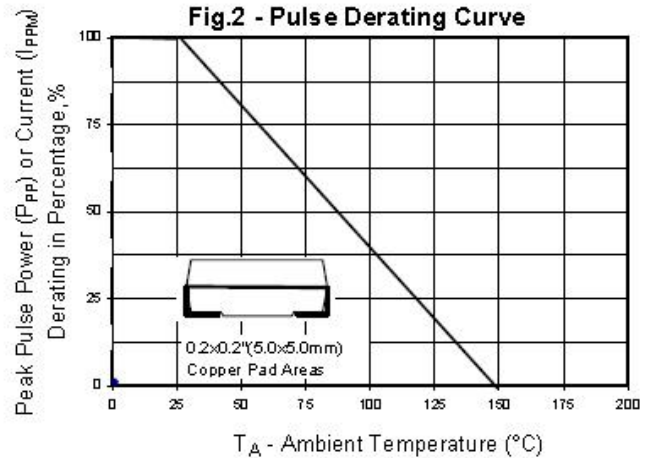

Fig.3 - Pulse Waveform

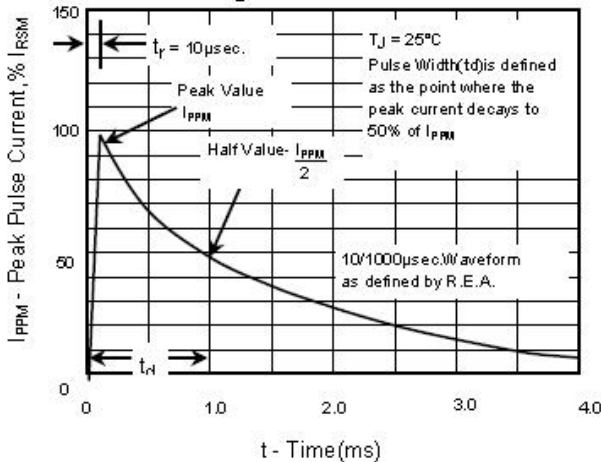
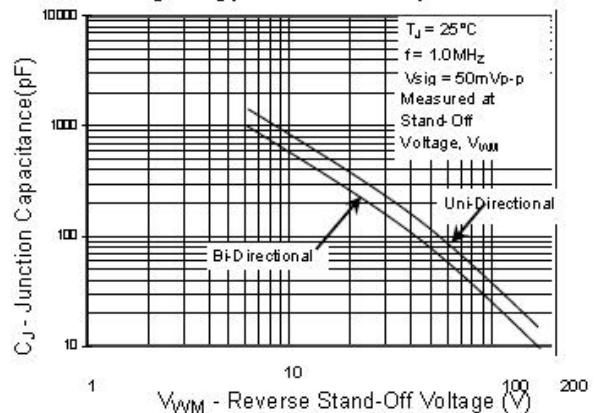
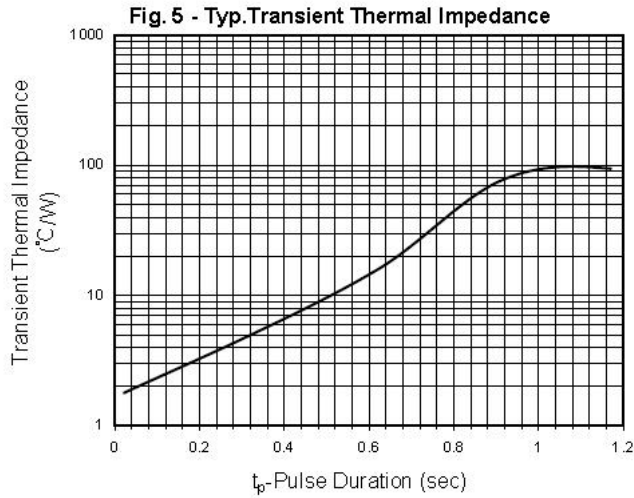
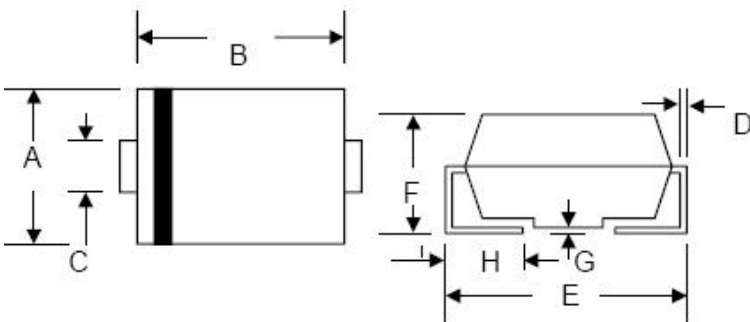

Fig.4 - Typical Junction Capacitance





Mechanical Dimensions SMA(Inches/Millimeters)



Dim.	SMA/DO-214AC			
	Min.	Max.	Min.	Max.
A	2.40	2.90	0.094	0.114
B	3.99	4.75	0.157	0.187
C	1.05	1.70	0.041	0.067
D	0.15	0.51	0.006	0.020
E	4.80	5.66	0.189	0.223
F	1.90	2.95	0.075	0.116
G	0.05	0.203	0.002	0.008
H	0.76	1.52	0.030	0.600
	In mm		In inch	

Carrier Tape Specification SMA

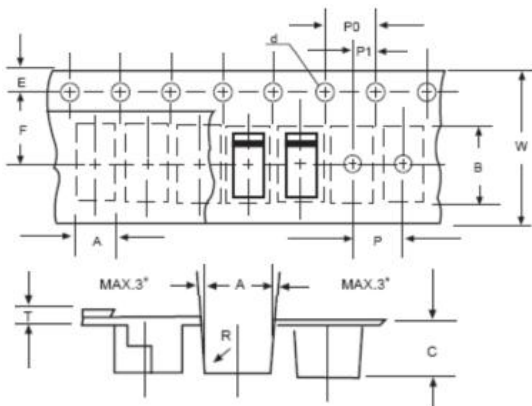

SYMBOL	Millimeters	
	Min.	Max.
A	2.97	3.17
B	5.70	5.90
C	2.32	2.52
d	1.40	1.60
E	1.40	1.60
F	5.60	5.70
P	3.90	4.10
P0	3.90	4.10
P1	1.90	2.10
T	0.25	0.35
W	11.80	12.20



DISCLAIMER:

1- The information given herein, including the specifications and dimensions, is subject to change without prior notice to improve product characteristics. Before ordering, purchasers are advised to contact the SMC - Sangdest Microelectronics (Nanjing) Co., Ltd sales department for the latest version of the datasheet(s).

2- In cases where extremely high reliability is required (such as use in nuclear power control, aerospace and aviation, traffic equipment, medical equipment, and safety equipment), safety should be ensured by using semiconductor devices that feature assured safety or by means of users' fail-safe precautions or other arrangement.

3- In no event shall SMC - Sangdest Microelectronics (Nanjing) Co., Ltd be liable for any damages that may result from an accident or any other cause during operation of the user's units according to the datasheet(s). SMC - Sangdest Microelectronics (Nanjing) Co., Ltd assumes no responsibility for any intellectual property claims or any other problems that may result from applications of information, products or circuits described in the datasheets.

4- In no event shall SMC - Sangdest Microelectronics (Nanjing) Co., Ltd be liable for any failure in a semiconductor device or any secondary damage resulting from use at a value exceeding the absolute maximum rating.

5- No license is granted by the datasheet(s) under any patents or other rights of any third party or SMC - Sangdest Microelectronics (Nanjing) Co., Ltd.

6- The datasheet(s) may not be reproduced or duplicated, in any form, in whole or part, without the expressed written permission of SMC - Sangdest Microelectronics (Nanjing) Co., Ltd.

7- The products (technologies) described in the datasheet(s) are not to be provided to any party whose purpose in their application will hinder maintenance of international peace and safety nor are they to be applied to that purpose by their direct purchasers or any third party. When exporting these products (technologies), the necessary procedures are to be taken in accordance with related laws and regulations..